

SILO S220

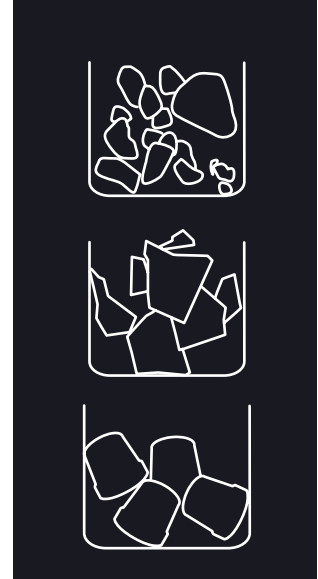













ICE BIN FOR MODULAR ICE MACHINES

FEATURES

- ▶ ICE BIN CAPACITY OF 230 KG
- ▶ AISI 304 STAINLESS STEEL BINS.
- ▶ VERY HARD SANITARY POLYETHYLENE VAT, RESISTANT TO BLOWS, AND SCRATCHES
- ▶ EASY CLEANING DESIGN®: SEAMLESS ONE-PIECE VAT WITH ROUNDED CORNERS, AVOIDING POSSIBLE DIRTY POINTS AND FACILITATING CLEANING
- ▶ DRAINAGE SYSTEM THAT COLLECTS AND DRIVES THE WATER TO THE DRAIN KEEPING THE BIN CLEAN & DRY



RECOMMENDED MACHINES

	MDP150/MR400/MP	SPIKA	QUASAR	ICE QUEEN	SCALA
 RECOMMENDED	 1/2 MDP150	 1/2 MS220	 MQ200	 IQ150	 IQ200
	 MP145	 MS300 SLIM		 IQ400	 IQ550
		 1/2 MS410		 IQ550 SPLIT	 IQ850 CO2SPLIT
 POSSIBLE (NOT OPTIMIZED)				 IQ1100 SPLIT	

TECHNICAL SCHEME

SILO S220

RIGHT SIDE VIEW

FRONTAL VIEW

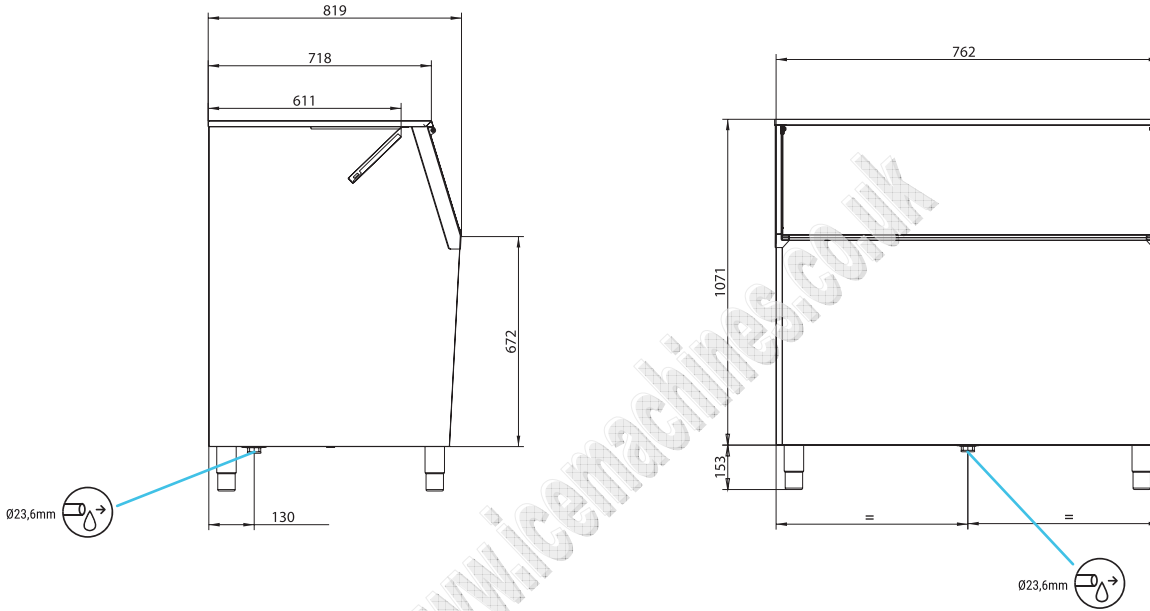

* All measurements in mm.

ACCESSORIES

INCLUDED



4 HEIGHT ADJUSTABLE LEG KIT



LARGE SCOOP



WATER OUTLET HOSE



DRAINAGE ELBOW

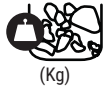

(m³)

SILO S220

230

184

Width 762
Depth 819
Height* 1.071

56

Width 850
Depth 890
Height 1.210

68

0,92

*1.224 mm with legs