

# SILO S500

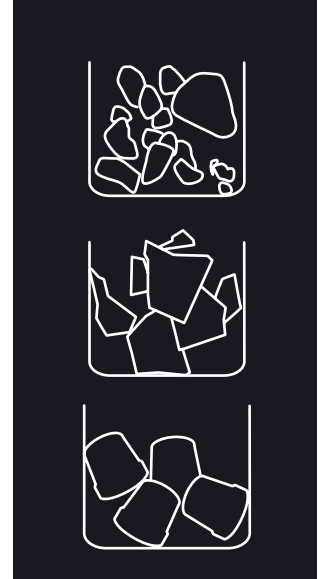













## ICE BIN FOR MODULAR ICE MACHINES

### FEATURES

- ▶ ICE BIN CAPACITY OF 480 KG
- ▶ AISI 304 STAINLESS STEEL BINS
- ▶ VERY HARD SANITARY POLYETHYLENE VAT, RESISTANT TO BLOWS, AND SCRATCHES
- ▶ EASY CLEANING DESIGN®: SEAMLESS ONE-PIECE VAT WITH ROUNDED CORNERS, AVOIDING POSSIBLE DIRTY POINTS AND FACILITATING CLEANING
- ▶ DRAINAGE SYSTEM THAT COLLECTS AND DRIVES THE WATER TO THE DRAIN KEEPING THE BIN CLEAN & DRY



### RECOMMENDED MACHINES

	MDP150/MR400/MP	SPIKA	QUASAR	ICE QUEEN	SCALA
  RECOMMENDED	 1/2 MR400	 2 MS220		 1/2 IQ400	 SCALA 400 SCALA 400 SPLIT
				 1/2 IQ550	 SCALA 600 SCALA 600 SPLIT
		 1/2 MS410		 1/2 IQ550 SPLIT	 SCALA 1000/1500/2000/3000 SPLIT
				 1/2 IQ850 CO2SPLIT	
				 IQ1100	
				 IQ1100 SPLIT	

  POSSIBLE (NOT OPTIMIZED)	 1/2 MDP150	 MS220	 MQ200	 1/2 IQ150
	 2 MP145	 MS300 SLIM		 1/2 IQ200

# TECHNICAL SCHEME

SILO S500

RIGHT SIDE VIEW

FRONTAL VIEW

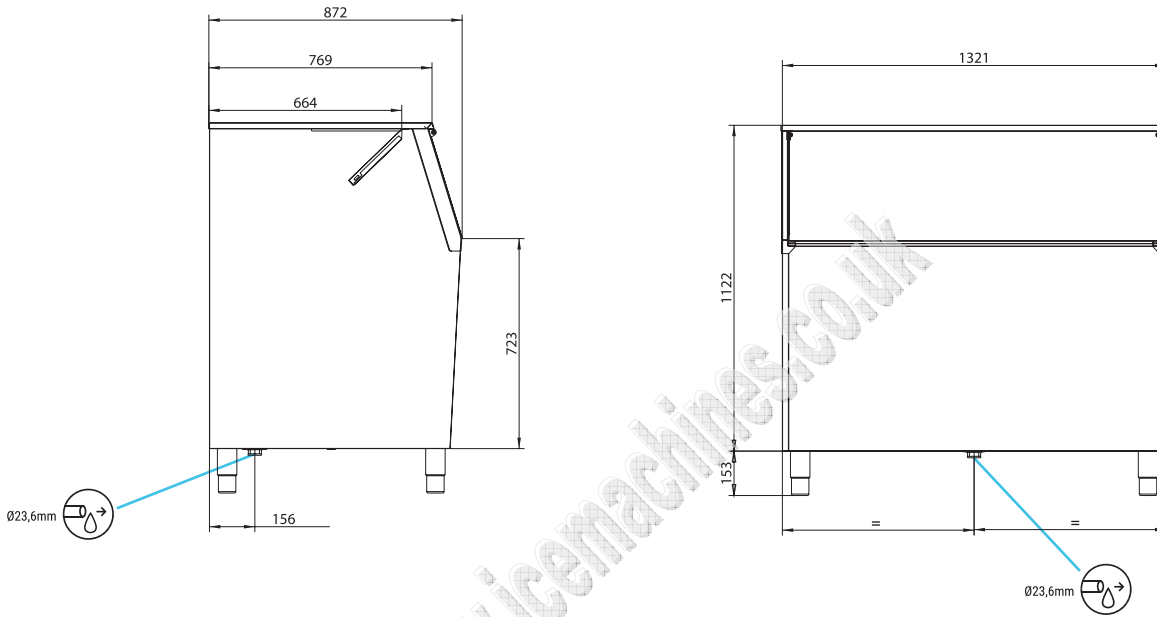

\* All measurements in mm.

## ACCESSORIES

### INCLUDED



4 HEIGHT ADJUSTABLE LEG KIT



LARGE SCOOP



WATER OUTLET HOSE



DRAINAGE ELBOW

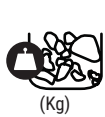

(Kg)



(Kg)



(mm)



(Kg)



(mm)



(Kg)

(m<sup>2</sup>)

SILO S500

480

384

Width 1.321  
Depth 872  
Height 1.122

94

Width 1.445  
Depth 1.000  
Height 1.285

120

1,86

\*1.275 mm with legs